



BRANDON 60K/80K/100K OIL FIRED COOKER



OPERATION INSTRUCTIONS

This Manual is to be left with end user.

TABLE OF CONTENTS

	PAGE NO.
1. Introduction	2
2. Technical Data	3
3. Burner Specification.	4
4. Operation	4
5. Pre-Operational Checks	4
6. Programmable Clock.	5
7. Setting the Correct Time & Day	5
8. Operating the Oven Manually	5
9. Setting The Cooking Programme	5
10. Programming Central Heating, Hot Water or Oven Pre-Heat.	6
11. Setting The Boiler Set Temperature	7
12. Setting The Alarm Timer	7
13. Boost Function.	8
14. Advance Function (In Auto Mode Only)	8
15. Display Lock Function	8
16. Power Failure	8
17. Hotplate / Cooking Mode.	9
18. Hotplate Insulating Covers	9
19. Cooking Utensils	9
20. Cleaning	9
21. Chimney Cleaning.	9
22. Mild Steel	10
23. Ovens	10
24. Hotplate	10
25. Opening Cooker Door	10
26. Cooking Guidance	11
27. General Information	11
28. Grilling.	11
29. The Care Of Your Cooker.	11
30. Servicing	11
31. Cookware	11
32. User Cooking Tips	13
33. Fault Findings.	14

INTRODUCTION

To help you make the best use of your cooker, **PLEASE READ THIS BOOKLET CAREFULLY.**

To ensure safety, satisfaction and reliable operation, this quality cooker should be installed and commissioned by a trained and competent person. The provision of the central heating facility and hot water systems involved, must conform to good plumbing practice, established standards and OFTEC recommendations.

As manufacturers and suppliers of cooking and heating appliances, we take every possible care to ensure as reasonably practicable, that these appliances are so designed and constructed as to meet the general safety requirements when properly used and installed.

Section 10 of the Consumer Protection Act 1987.

Safety, Health and Welfare at Work Act.

The complete installation must be done in accordance with current Standards and Local Codes. It should be noted that the requirements and these publications may be superseded during the life of this manual. Your new cooker is guaranteed, the guarantee is only applicable if the cooker has been installed in accordance with the Installation Instructions.

IMPORTANT NOTICE: Any alteration to this appliance that is not approved in writing by Waterford Stanley will render the guarantee void.

The cooker is designed specifically for domestic use and responsibility will not be accepted for use in any other installation. When the Cooker is first used, a slight odour may be noticed - this should cease after a short period of use.

The Installation must comply with the following:

B.S. 5410: Oil Installations Part 1 under 45kW.

The Building Regulations : Part J England & Wales Part F Section 4 Scotland.

Part L Northern Ireland and Part J Ireland.

The Control of Pollution (Oil) Regulations.

B.S. 5449: Forced circulation hot water, central heating systems for domestic installations.

Health and Safety at Work Act.

B.S. 7671: Requirements for Electrical Regulations.

Safety Document 635: The Electricity at Work Regulations.

B.S. 7593: Treatment of Water in Domestic Hot Water Systems.

B.S. 7074: Part 1 & 2: Hot Water Supply.

B.S. 4814: Sealed System.

Important: Control of Substances Harmful to Health -

It is the Users/Installers responsibility to ensure that the necessary personal clothing is worn when handling materials that could be interpreted as being injurious to health and safety.

When handling Firebricks, Fire Cement or Fuels, use disposable gloves.

Exercise caution and use disposable masks and gloves when handling glues and sealants.

When working with fibre glass, mineral wool, insulation materials, ceramic blanket/board, avoid inhalation as it may be harmful if inhaled. Avoid contact with skin, eyes, nose and throat, use disposable protection.

Installation should be carried out in a well ventilated area.

This combined appliance is capable of providing 29.3 kW (100,000 Btu's/hr) or 23.45 kW (80,000 Btu's/hr) or 17.58 kW (60,000 Btu's/hr) to water, 2.96kW (10,113 Btu's/hr) for hotplate, space heating and ovens.

When the appliance is set to cooking mode it will also provide hot water to the domestic system and space heating.

Heat transfer to the domestic system when oven is set to 230°C (446°F)

Mean Output: 4,820 Btu's/hr

This appliance is hot while in operation and retains its heat for a long period of time after use. Children, aged or infirm persons should be supervised at all times and should not be allowed to touch the hot working surfaces while in use or until the appliance has thoroughly cooled.

TECHNICAL DATA

FUEL:	28 Sec Kerosene	MAX BOILER WORKING PRESSURE:	1.9 bar	27.3 P.S.I.
MAINS CURRENT:	230v - 240v, 50 Hz A.C.	TEST PRESSURE OF BOILER:	3 bar	43.5 P.S.I.
I.P. PROTECTION:	IP 20	OPERATING TEMPERATURE LIMIT IN BOILER:	96°C	205°F
ELECTRICAL INPUT:	90 Watts			
SUPPLY FUSE RATING:	3A			

100K

BOILER OUTPUTS:	29.3kW - 100,000 Btu's/Hr.
RADIATION SURFACE:	53 m ² (571 ft. ²) heating surface only. 48 m ² (514 ft. ²) heating surface and domestic hot water.
FLUE GAS FLOW:	Boiler: 0.005m ³ /s Oven: 0.0026m ³ /s.
SPACE HEATING:	2.91 kW (10,000 Btu's/hr) cooking mode / 0.7 kW (2,500 Btu's/hr) boiler mode.
FLUE GAS TEMPERATURE:	Boiler 180°C (350°F) Cooker 250°C. (482°F)
ELECTRICAL SUPPLY:	240V 50Hz
FUSE:	3A.
BOILER CAPACITY:	17 litres (3.74 Gal.).
BOILER MATERIAL:	Mild steel.
COOKER WEIGHT:	385Kg (850 lbs).

80K

BOILER OUTPUTS:	23.45kW - 80,000 Btu's/Hr.
RADIATION SURFACE:	42.5 m ² (457 ft. ²) heating surface only. 37.2 m ² (400 ft. ²) heating surface and domestic hot water.
FLUE GAS FLOW:	Boiler: 0.0044m ³ /s Oven: 0.0026m ³ /s.
SPACE HEATING:	2.91 kW (10,000 Btu's/hr) cooking mode / 0.68 kW (2,300 Btu's/hr) boiler mode.
FLUE GAS TEMPERATURE:	Boiler 200°C (392°F) Cooker 230°C. (450°F)
ELECTRICAL SUPPLY:	240V 50Hz
FUSE:	3A.
BOILER CAPACITY:	17 litres (3.74 Gal.).
BOILER MATERIAL:	Mild Steel.
COOKER WEIGHT:	380Kg (838 lbs).

60K

BOILER OUTPUTS:	17.58kW - 60,000 Btu's/Hr.
RADIATOR SURFACE:	32 m ² (344.45 ft. ²) heating surface only. 26.5 m ² (285 ft. ²) heating surface and domestic hot water.
FLUE GAS FLOW:	Boiler: 0.0031m ³ /s Oven: 0.0026m ³ /s.
SPACE HEATING:	2.91 kW (10,000 Btu's/hr) cooking mode / 0.7 kW (2,500 Btu's/hr) boiler mode.
FLUE GAS TEMPERATURE:	Boiler: 170°C (356°F) Cooker: 250°C. (482°F)
BOILER CAPACITY:	17 litres (3.74 Gal.).
BOILER MATERIAL:	Mild steel.
COOKER WEIGHT:	385Kg (850 lbs).

THIS APPLIANCE MUST BE CONNECTED TO A FULLY PUMPED SYSTEM.

BURNER SPECIFICATION

	BOILER BURNER			COOKER BURNER
	100K	80K	60K	100K/80K/60K
Burner Input				
(kW) Continuous Running	34.2	27.7	21.4	19.5
(kW) Cycling	N/A	N/A	N/A	4.4
(Btu's) Continuous Running	116,760	94,600	73,000	66,875
(Btu's) Cycling	N/A	N/A	N/A	14,950
Boiler Output				
(kW) Continuous Running	29.3	23.5	17.6	2.1
(kW) Mean Cycling	N/A	N/A	N/A	1.2
(Btu's) Continuous Running	100,000	80,000	60,000	7,000
(Btu's) Mean Cycling	N/A	N/A	N/A	4,000
Nozzle	0.85 80°S (C.E.N)	0.65 80°S (C.E.N)	0.55 80°S (C.E.N)	0.5 60°S (C.E.N)
Pressure				
(Bar)	7.4	7.4	7.1	7.1
(PSI)	107	108	103	110
Fuel Consumption				
(L/Hr) Continuous Running	3.6	2.9	2.2	2.1
(L/Hr) Cycling	N/A	N/A	N/A	0.47
US Gal/Hr				
Continuous Running	0.95	0.77	0.58	0.55
US Gal/Hr Cycling	N/A	N/A	N/A	0.12

All data are taken under laboratory conditions and may vary in use

Differential Pressure Across the Boiler

Design flow rate through the boiler	38.2 L/min / 8.4 Gpm
Static differential across the boiler	52.4 mbar / 21" wg
Dynamic pressure differential across the boiler	33 mbar / 13.23" wg

Note: Design temperature differential across the boiler = 11°C (20°F)

This appliance conforms to the following:

Low Voltage Equipment: 72/23/EEC
95/68/EEC

Electromagnetic Compatibility: 89/336/EEC
92/31/EEC
93/68/EEC



OPERATION

PRE-OPERATIONAL CHECKS

(a) Check that the cooker is connected to the mains electrical supply.

“WARNING THIS EQUIPMENT MUST BE EARTHED”

(b) Check that all valves in the oil line are open and

that the filter and oil pump are purged of air.

(c) Check that appliance thermostats are in the off position.

(d) Check that the boiler and heating system is full of water and purged of air.

PROGRAMMABLE CLOCK

Fig1

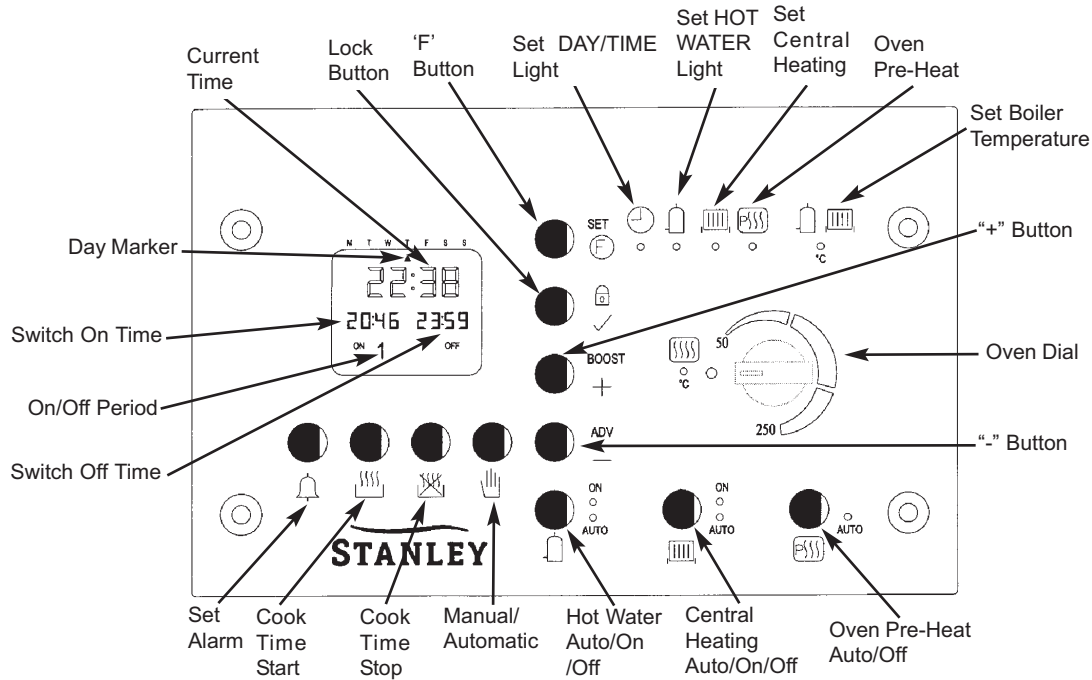

The programmable clock controls your central heating system and oven preheat function, and allows you to set your cooking times automatically. The clock offers the following features:

- * 7-Day heating programme.
- * Three ON/OFF switching times each day.
- * Facility allowing a separate heating programme for Weekdays (MON-FRI) and a different programme for the Weekend (SAT-SUN).
- * Separate programme facilities for Central Heating, Hot Water and Oven preheat needs.
- * Independent oven timer.
- * Advance buttons for Central Heating, PreHeat and Hot Water functions.
- * Boost Facility for Central Heating and Hot Water functions.
- * Alarm Timer allowing timing of cooking.
- * Built-in battery to prevent loss of programmes during power cuts.
- * Diagnostics.

GENERAL NOTE ON SETTING THE PROGRAMMER

When there is a time or setting that can be edited, or adjusted by the user, then that time flashes to indicate that it is editable. Editing is carried out by scrolling the + or - buttons. These buttons have a different function when there are no editable times.

SETTING THE CORRECT TIME AND DAY (See Fig.2)

1. Press the "F" button and hold it for five seconds. The red "SET DAY/TIME" light will illuminate and the arrow signifying the day setting will flash.
2. Adjust the day setting by pressing the + or - buttons, until the day marker is pointing to the correct day.
3. Press the "✓" button to accept the setting, then the hour figure will flash. Adjust the hour setting by pressing the + or - buttons.
4. Press the "✓" button and the minutes figure will flash. Adjust the minute setting by pressing the + or - buttons.
5. Press the "F" button five times to exit the setting time facility.(or simply do nothing – the setting mode will revert to the normal mode after 60 seconds)

Fig2

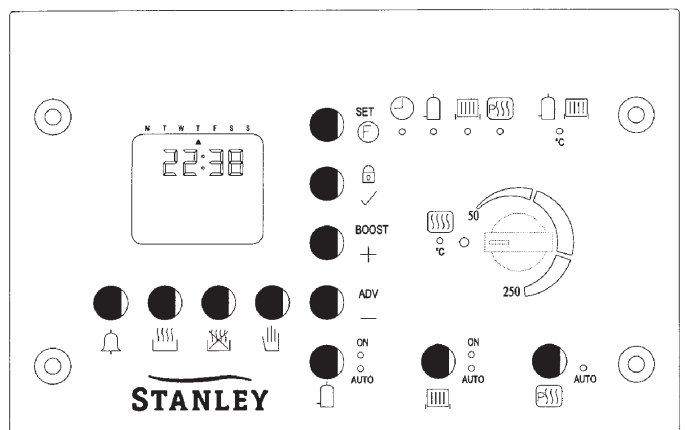

OPERATING THE OVEN MANUALLY

- Simply turn the oven temperature control until the temperature desired appears on the LCD screen. (If oven ON and OFF times are shown, cancel the oven timer by pressing the Oven Manual button)
- When cooking is finished, to turn the oven OFF, rotate the temperature control fully anticlockwise
- Tip:** If you use the oven pre-heat, the oven will attain the set temperature much more quickly! Simply program pre-heat to come on about half an hour before you normally would start cooking.

Fig3

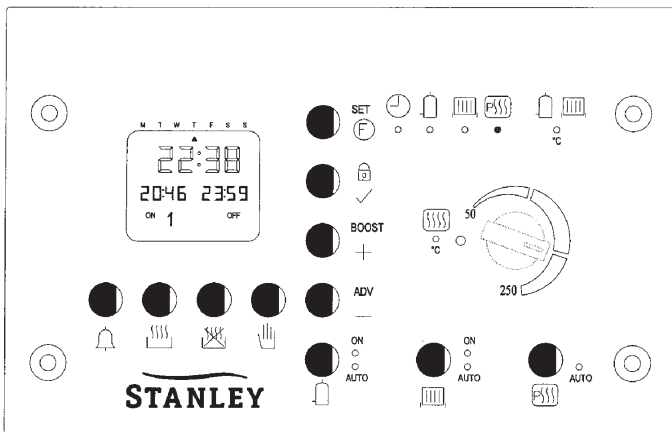
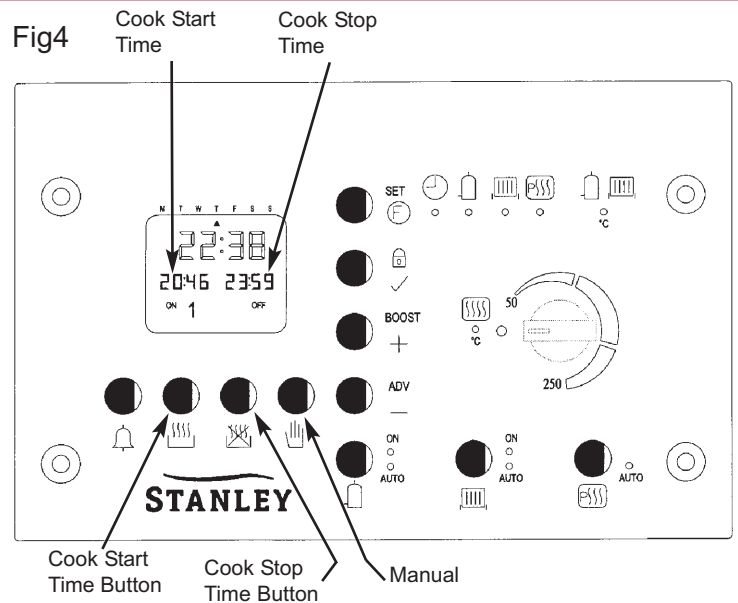

Fig4



PROGRAMMING CENTRAL HEATING, HOT WATER OR OVEN PREHEAT

The heating can be set individually for both Central Heating, Hot Water, and Oven preheat and each setting has 3 on/off programmes for each day. These can be set in three different ways:

- All 7 Days simultaneously.
- First Monday-Friday, then Saturday & Sunday
- Each Day Individually.
 - Press the "F" button and hold it for five seconds until the red "SET DAY/TIME" light illuminates. Press the "F" button again and the red light moves to set Domestic Hot Water. Each subsequent time it is pressed the mode will move on to the next position.
 - The display will be as shown in Fig 4, with the arrow flashing underneath the day you wish to program for. The time on the bottom left and bottom right sides are the ON and OFF times respectively. The number "1" at the bottom of the display signifies that these are the times for the first ON/OFF setting of the day/days.
 - The programs can be set for the individual days, for weekdays, for weekends and for the entire week. The days you wish to program for can be changed by moving the flashing arrow using the + and - buttons. Fig 5 (a) shows the day setting for setting the same programme for Monday to Friday, Fig 5 (b) shows it for setting the same programme for Saturday & Sunday and Fig 5 (c) shows it for setting the same programme for the entire week.

SETTING THE COOKING PROGRAMME

- Press the " " button and the "SWITCH ON" and "SWITCH OFF" times will appear below the current time display. (see Fig 3)
- To set the cook start time, press the " " button and the "COOK START" time will flash.
- Adjust it to the desired start time using the + or - buttons.
- To set cook stop time, press the " " button and the "COOK STOP" time will flash.
- Adjust it to the desired finish time using the + or - buttons.
- Set the oven thermostat to the required temperature.
- To return to Manual oven cooking, press the " " button.
- If desired, you can leave the oven timer selected, in which case the oven will come on to the selected temperature at the same time every day.

4. After selecting the day, press the “✓” button and the 1st ON time will flash. This time can be adjusted in ten minute intervals using the + and - buttons.

5. Press the “✓” button and the corresponding OFF time can be adjusted using the + and - buttons.

Note that you cannot set an OFF time to be earlier than ON time, or the ON time to be earlier than the previous OFF time. The programmer will automatically correct settings if you do this.

6. The 2nd & 3rd ON/OFF times can be viewed by pressing the “✓” button and can be set by repeating Steps 4 & 5

7. Note that if you do not want to use all three ON/OFF times, simply set the OFF time the same as the ON time.

8. To exit DHW setting press the “F” button four times, or press once to edit the Central heating programs. Press once more to edit the pre-heat programs in just the same way.

9. To have the appliance operate on the programmed settings, press the appropriate button on the right hand side of the control panel once so that a light can be seen beside auto.

Fig 5A

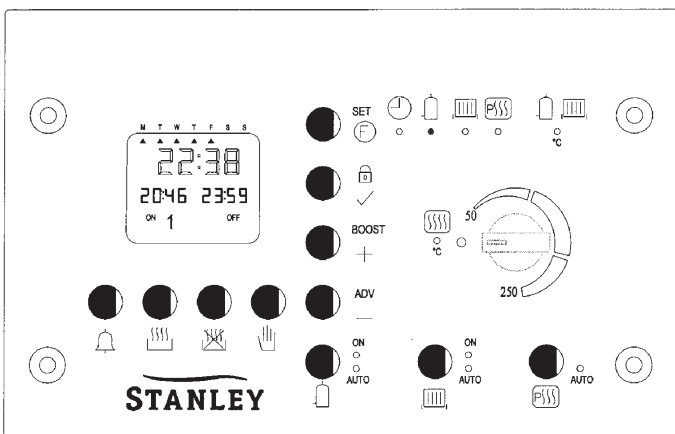

Fig 5B

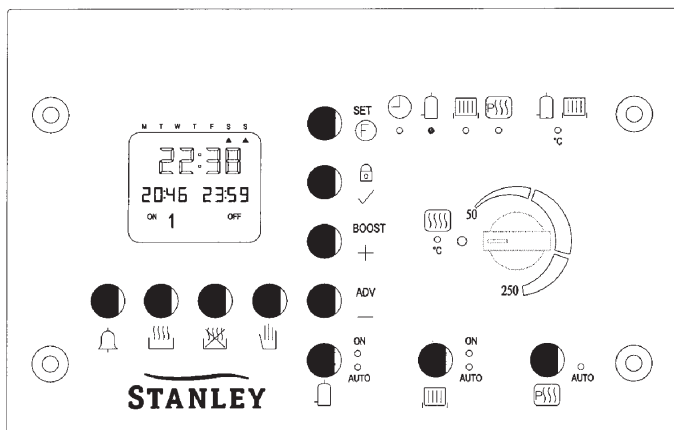
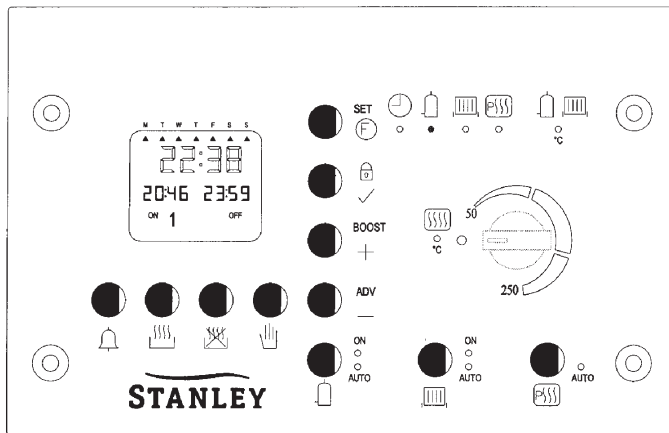

Fig 5C



SETTING THE BOILER SET TEMPERATURE

1. Press the "F" button and hold it for five seconds until the red "SET DAY/TIME" light illuminates. Press the "F" button repeatedly until the LED beside "°C" is illuminated. The boiler set temperature will be displayed.
2. The boiler set temperature can be adjusted between the limits 60 – 80 °C by pressing the + and - buttons.

Fig 6

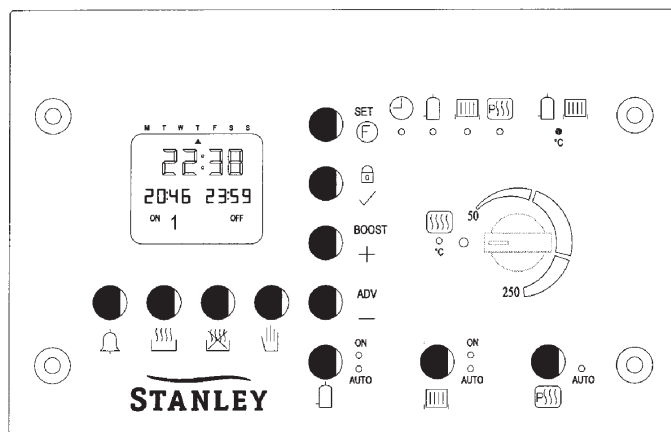

SETTING THE ALARM TIMER

The alarm timer allows cooking to be timed up to a period of 99 minutes. (it does not turn the oven on or off) The alarm can be set by following the procedure below:

1. Press the "alarm" button and a "00 ALARM" will flash on the display (See Fig 6).
2. Adjust the alarm time to the desired setting using the + or - buttons.
3. The timer will start immediately when the setting + or - button is released.



- When the time has elapsed, the acoustic signal will sound for 60 seconds and the word Alarm flashes. It can be cancelled by pressing the Alarm button.

Note: This timer operates only when the oven is set to "manual" mode.

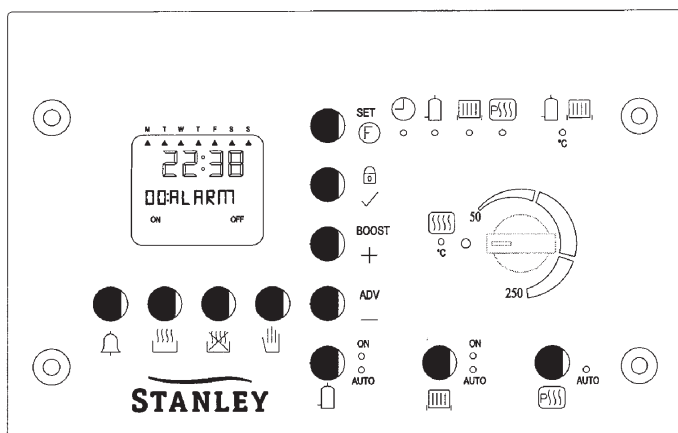
Fig 7





BOOST FUNCTION

By pressing the "BOOST" button, boost will be displayed and the symbols for central heating and hot water will flash. Then pressing either the "Hot Water", "Central Heating" or "Pre Heat" buttons will turn this mode on for 1 hour. The symbols will flash for 10 seconds and if neither of the 3 options are selected then the display will revert to current time and day. If a mode is selected the symbol for this mode and the word "BOOST" will remain displayed for 1 hour, providing none of the oven control functions on the clock are used within this hour. Boost can be cancelled by pressing the relevant function button, i.e.   

ADVANCE FUNCTION (IN AUTO MODE ONLY)

By pressing the "ADV" button, ADVANCE will be displayed and the symbols for central heating and hot water will flash. Then pressing either the "Hot Water" or "Central Heating" or "Pre-heat" buttons will bring forward the next switching time for that mode. The symbols will flash for 10 seconds within which one of the 3 options must be selected before the display will revert to current time and day.

Advance can be cancelled by pressing the relevant function button, i.e.   

Note: Advance function is only applicable when timer is in 'Auto Mode'.

The DHW, Heating and oven Pre-heat programs can be turned OFF by de-selecting AUTO, so that no lights are visible.

The DHW and Heating can also be set to continuous ON by pressing the button so that the ON light illuminates.

DISPLAY LOCK FUNCTION

By pressing and holding the "LOCK" Button for 10 seconds the display will become locked, and LOCKED will be displayed. To unlock the display press and hold the "LOCK" button for 10 seconds. If any button is pressed while the display is locked the word "LOCKED" will flash on the display.

POWER FAILURE

Your clock has a built-in battery to ensure correct operation after a mains supply power cut. No action should be necessary following a power loss.

Diagnostics

If an error occurs in the appliance the electronics will detect it and narrow down the problem area.

- Code no 1. Oven thermocouple failure
- Code no 2. Boiler thermistor failure
- Code no 3. Flue thermistor failure (Gas only)
- Code no 4. Boiler high limit switch opened
- Code no 5. Oven high limit switch opened
- Code no 6. Flue thermistor over temperature (Gas only)
- Code no 8. Oven burner faulty
- Code no 9. Boiler Excess Temperature

When an error occurs it can be reset by pressing the "✓" button for 5 seconds, the code no. on the display will disappear, if the error is still present the code no. will reappear, it will be necessary to call the Stanley service centre.

In the special case of a no. 9 code this could be due to all radiator valves being turned off. It is a requirement that at least 1 radiator in zone 1 is permanently on.

If Code 4 or 5 appear on the display screen prior to the fault being cleared using the F button, it will require the high limit switches to be reset, to access and reset the high limit switches take the following steps:

- Remove plinth at base of cooker, the high limit switches are located in the centre of the base plate, see Fig.8.
- Press the LH & RH buttons to reset the High Limit reset switches, then press the F button for 5 seconds to clear the fault on the display screen.

However, if the high limit does not reset it may be due to the appliance being excessively hot, wait until the appliance has cooled and press the high limit switches again, if they do not reset when appliance is cool, please contact your local service engineer.

Fig 8

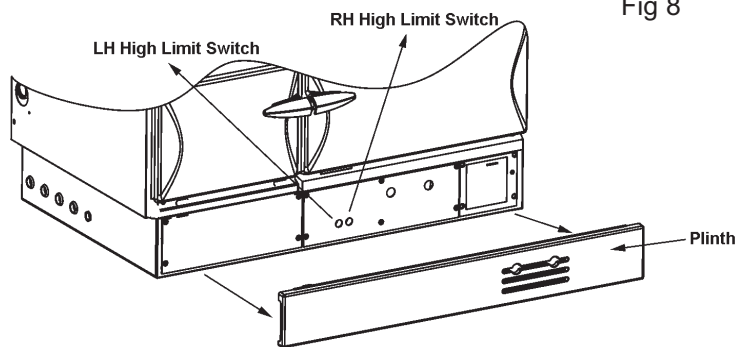

HOT PLATE / COOKING MODE

The hot plate is machined ground for maximum heating and it is temperature graded, the left hand side over the burner being the hottest and the right hand side is suitable for simmering.

HOTPLATE INSULATING COVERS

The insulating covers retain most of the heat that would otherwise be radiated into the kitchen. They also retain the heat in the hot plates so that rapid heating of cooking utensils will occur when one or both of them are lifted for cooking purposes.

Fig.9

Fig.9a

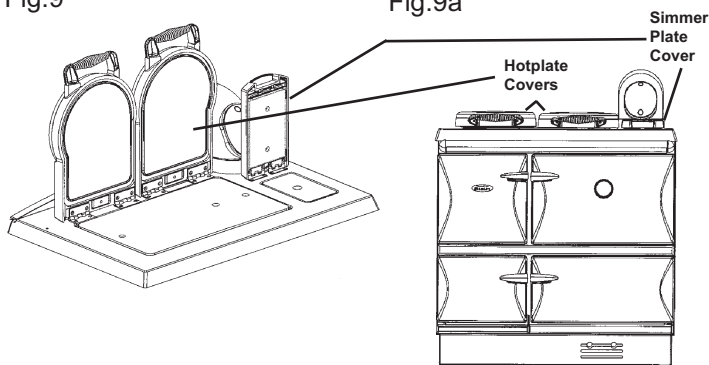

IMPORTANT: WHEN HOTPLATE IS NOT IN USE ENSURE THAT HOTPLATE COVERS ARE IN A DOWN POSITION.

COOKING UTENSILS

For best cooking results and economy of operation use heavy based, flat bottomed utensils.

IMPORTANT: WE DO NOT RECOMMEND DEEP FAT FRYING ON THIS APPLIANCE.

IMPORTANT: DO NOT USE MIS-SHAPED PANS WHICH MAY BE UNSUITABLE. DO NOT USE ROUND BASED WOKS.

CLEANING

IMPORTANT: BE CAREFUL OF THE HOT APPLIANCE.

General cleaning must be carried out when the cooker is cool.

Stanley cookers are finished in a high gloss vitreous enamel. To keep the enamel in the best condition observe the following tips:

1. Wipe over daily with a soapy damp cloth, followed by a polish with a clean dry duster.
2. If milk, fruit juice or anything containing acid is spilt on the hob or down the cooker, be sure to wipe it immediately or the vitreous enamel may be permanently discoloured.
3. Keep a damp cloth handy while cooking, to wipe up any spills as they occur, so they do not harden and become more difficult to remove later.
4. If spills do become baked on, a cream cleanser can be used. For stubborn deposits a soap impregnated pad can be carefully used on the vitreous enamel.
5. Use only products recommended by the Vitreous Enamel Association, these products carry the Vitramel label.

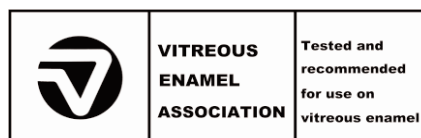

6. In the oven, spills and fat splashes are carbonised at high temperatures: occasionally brush out with a stiff brush. The shelves can be soaked and cleaned with a cream cleanser.
7. Both insulating covers should be raised and allowed to cool before cleaning the enamel with a soapy damp cloth. Use a wire brush to keep the cast iron hotplate clean.

DO NOT USE ABRASIVE PADS OR OVEN CLEANERS CONTAINING CITRIC ACID ON ENAMELLED SURFACES. ENSURE THAT THE CLEANSER MANUFACTURERS INSTRUCTIONS ARE ADHERED TO.

CHIMNEY CLEANING

Whichever type of flue is chosen, there must be cleaning access to the whole of the flue system. The flue of the chimney will need to be cleaned regularly. The combustion products of any burning appliance will have a descaling effect on hardened soot deposits left from burning solid fuels.

Although, the chimney may have been cleaned of loose soot prior to installation, it is imperative that the chimney is inspected for scaled soot particles after the first month of operation and any loose material removed to avoid blockage.

The frequency of cleaning will depend a lot on how your cooker is run, but to start with, make a point of inspecting the flue system every six months. This period may well be extended to twelve months as time goes by if there is little sign of deposits.

MILD STEEL

The steel panels and splash back (if fitted) must not be cleaned with steel wool. Use only washing up liquid in hot water with a lint free cloth. Dry off and apply a coat of good quality furniture polish.

OVENS

Grease spillages will burn off from the oven interior, when the oven is hot and any other loose materials can be wiped out with a cloth, when cold. Stubborn stains in the area and on the shelves in the oven can be cleaned off with a paste of bread soda and water

HOT PLATE

The hotplate may be cleaned by using a fine steel wool pad to remove rust or cooking stains. Dry off with a lint free cloth and apply a light coat of cooking oil to preserve the finish.

OPENING COOKER DOOR

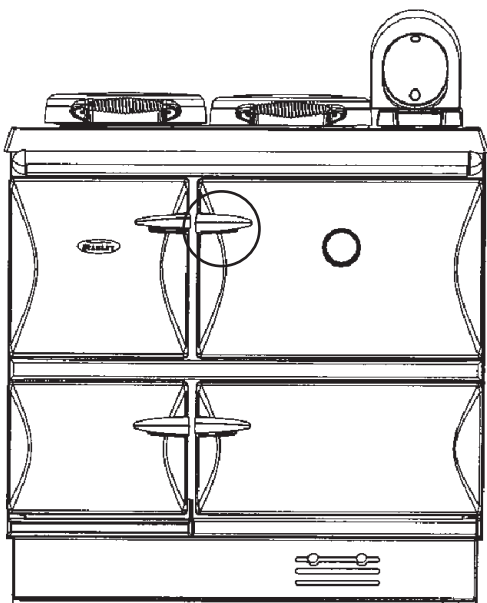

Fig.A

To open the cooker door grip the door handle between the fingers and thumb as per Fig.C, lift the door handle in an outward and upward direction as shown in Fig. D.

Fig.B

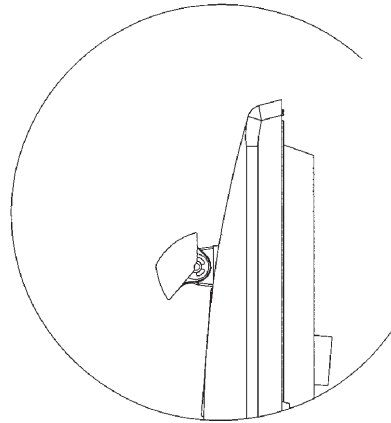

Fig.C

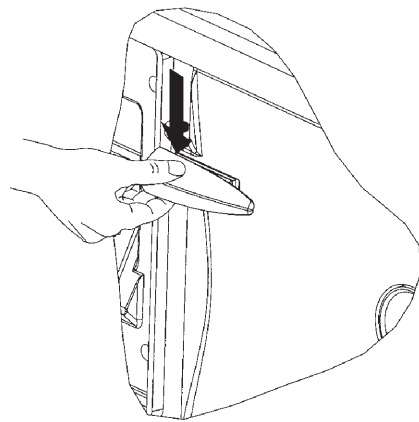

Fig.D

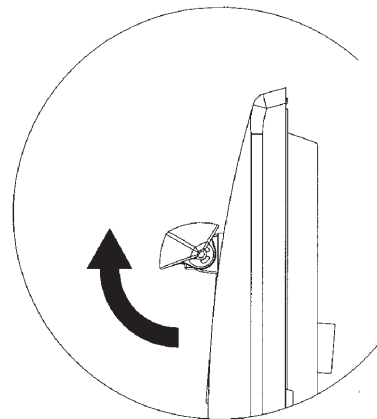
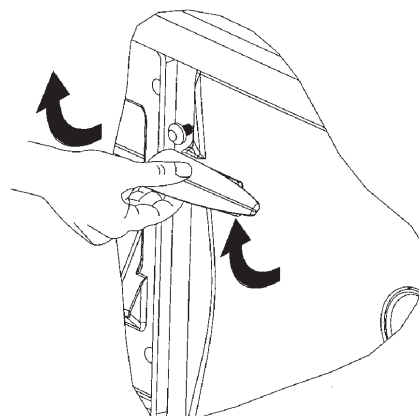

Fig.E



COOKING GUIDANCE

GENERAL INFORMATION

GRILLING

Turn the oven thermostat to a reasonably high setting and this will give a greater temperature at the top of the main oven. The flue gases are passing over the top face of this oven, so this face is being heated on both sides. The roasting tin supplied with the cooker contains a grill rack. Place any foods that require grilling onto the rack, and place the roasting tin as near to the top of the oven as possible. For any gratin type recipe that requires browning, place the dish on a shelf as near to the top of the oven as it will allow. For a delicious breakfast, lightly grease the base of the roasting tin and place slices of bread with a hole cut out of the centre, onto the base, carefully breaking an egg into each hole. Foods such as mushrooms and halved tomatoes can be placed around the eggs. Place the grilling rack over the eggs and lay the bacon, sausage, black pudding etc., onto the grilling rack. The fat will drop onto the eggs, helping to cook and flavour them. Fatty foods such as lamb cutlets are best suited to this method of oven grilling, most of the fats are drawn out into the roasting tin. Certain foods with little fat, benefit from pan frying/dry frying, using a ribbed frying or griddle pan. The foods cooked this way look attractive with the bar markings from the pan.

THE CARE OF YOUR COOKER

The vitreous enamel finish on your cooker is tough and hard wearing but should be treated with care. Acidic spills on the hob should be wiped off with a clean damp cloth. The vitreous enamel front, sides and hob only need a wipe with a warm soapy cloth, then a polish with a dry one. Do not use an abrasive cleaning material on the vitreous enamel. If there are stubborn marks on the hob, use a good quality enamel cleaner. Look for cleansers carrying the VEA (Vitreous Enamel Association) Follow the manufacturers instructions carefully. The hotplate will carbonise any food spilt on it, which should be removed with a wire brush or metal scraper. This will ensure a good contact between cooking utensil and the hotplate. Take care when cleaning the insulating lids, the hotplate may be hot. The ovens are self cleaning, any food that spills on the oven floors will carbonise and can be brushed or scraped away. It is often easier to use the vacuum cleaner to remove all the bits.

SERVICING

We recommend that the cooker be serviced by a trained competent person every twelve months in accordance with the manufacturers instructions.

COOKWARE

You do not have to rush out and buy a new set of pans when you take delivery of your new Stanley cooker, but it is advisable to check your cookware. Thin, lightweight saucepans are liable to buckle, so it is recommended that you use saucepans which have a flat, thermic base. This design of saucepan will give you complete contact with the hotplate and maximum heat retention for a good cooking performance. This design is usually of 18/20 stainless steel, with the thermic base encapsulated onto the bottom of the pan. The base will have a core of aluminium sandwiched between two layers of stainless steel. The aluminium does not come into contact with the food while cooking, but will very quickly pick up the heat and evenly distribute it over the base of the pan. Some continental designs of saucepans will have this inner sandwich of aluminium, not only at the base but up the sides as well. Many people prefer the look of cast iron cookware. This cookware is just as versatile as stainless steel, absorbing and distributing the heat evenly, and serving from the oven to table. They are available in a range of colours and designs, some with knobs and handles of a heat resistant material. Good quality saucepans can be expensive to buy, but the versatility they offer means that fewer items need to be purchased. Oven proof earthenware will also produce satisfactory results. Your traditional cake tins, baking trays, loaf tins and any other favourite ovenware you use, will be suitable. There is a bakeware on the market of Continental design which has a steel base, ideal for quickly absorbing the heat. It is covered with a magnum (enamel like) coating, which is safe to cut on, non stick effect and easy to clean. A roasting tin, containing the grilling rack is provided. You can use a pressure cooker on the hotplate but however, do check that the base of the pressure cooker makes good contact with the hotplate.

All timings are guidelines only, as there are no set rules for roasting meat - each cut lends itself to several different ways of preparation and cooking and each family will have a preference. When meat is roasted quickly the juices are sealed in, preserving the full flavour, but there will sometimes be shrinkage. Slow roast at a lower temperature method will reduce shrinkage and give a more tender joint.

Whichever roasting method you choose, the joint should first be weighed to calculate the cooking time. Place the meat on the grilling rack in the roasting tin, fat side uppermost. This will baste the meat as it is cooking, but check the roast from time to time and using a metal spoon, baste the meat yourself.

If you are using a meat thermometer, do take care when inserting it that it does not touch bone or excess fat. This will give you a false internal reading.

Stuffed joints of meat will need extra cooking time - approximately 10 minutes more for every 500g (1 lb).

TYPE OF MEAT	TEMPERATURE	TIMING per 500g (1 lb)
BEEF ON THE BONE SIRLOIN FORE RIB	180°C	RARE 10 mins + 10 mins over MED 12mins + 12 mins over WELL DONE 20 mins + 20 mins over
BEEF BONED AND ROLLED TOPSIDE TOP RUMP FILLET ROLLED RIB	180°C	RARE 12 mins + 12 mins over MED 15 mins + 15 mins over WELL DONE 20 mins + 20 mins over
PORK ON THE BONE SHOULDER LOIN LEG	180°C	25 mins + 25 mins over
PORK BONED AND ROLLED SHOULDER LOIN LEG	180°C	30 mins + 30 mins over
LAMB ON THE BONE CROWN GUARD OF HONOUR LEG BEST END LOIN	180°C	MED 20 mins + 20 mins over WELL DONE 25 mins + 25 mins over
LAMB BONED AND ROLLED	180°C	MED 25 mins + 25 mins over WELL DONE 30 mins + 30 mins over
VEAL BONED AND ROLLED TOPSIDE SHOULDER FILLET	180°C	MED 20 mins + 20 mins over WELL DONE 25 mins + 25 mins over
VENISON ON THE BONE HAUNCH (LEG) SADDLE	180°C	RARE 12 mins + 12 mins over MED 15 mins + 15 mins over WELL DONE 20 mins + 20 mins over
RABBIT/HARE	180°C	Up to 1 kg (2 lb): 45 - 60 mins Up to 2 kg (4 1/2 lb): 60 - 90 mins
CHICKEN	190°C	20 mins + 20 mins over
TURKEY 3.6 - 4.5 kg (8 - 10 lb) 4.9 - 5.4 kg (11 - 12 lb) 5.4 - 6.3 kg (12 - 14 lb) 6.3 - 7.2 kg (14 - 16 lb) 7.2 - 8.1 kg (16 - 18 lb) 8.1 - 9 kg (18 - 20 lb)	160°C	3 1/2 - 3 3/4 hrs 3 3/4 - 4 hrs 4 - 4 1/2 4 1/4 - 4 1/2 hrs 4 1/2 - 4 3/4 hrs 4 3/4 - 5 hrs
DUCK	200°C	MED 25 mins + 25 mins over WELL DONE 30 mins + 30 mins over
GOOSE	180°C	20 mins + 20 mins over
PHEASANT	200°C	50 - 60 mins total cooking
GROUSE	220°C	30 - 45 mins total cooking
PARTRIDGE	220°C	45 mins total cooking

RECIPE NOTES

Eggs used are size 3 unless otherwise stated.

All herbs used are fresh unless otherwise stated. If unavailable use dried herbs in half the quantity stated.

Milk should be full-fat unless otherwise stated

Spoon measures are level unless otherwise stated.

USER COOKING TIPS

You will soon come to look upon the Stanley as a reliable companion to help you during a busy baking session or when you are preparing that extra-special meal. The following tips are ways in which you will find the Stanley invaluable: no doubt you will quickly add discoveries of your own to the list.

- 1. Baking:** If you are using butter or margarine from the refrigerator, simply place the required amount of fat in a heatproof bowl on the hob, near to the hotplate. It will be quickly brought to room temperature, making it easier to work with.
- 2. Breadmaking:** Stand the required liquid for the recipe in a heatproof jug on the hob near the hotplate to warm. Take care not to overheat as yeast is killed at high temperatures.
- 3. Breadmaking:** Depending on what mode the cooker is set at, the hob, plate rack or lower oven can be used for proving the dough.
- 4. Baking:** To dissolve gelatine, place two tablespoons of water or liquid from the recipe in a small heatproof bowl. Sprinkle the required amount of gelatine on the liquid and place on or near the hotplate to dissolve. A small stainless steel bowl is useful for this type of job.
- 5. Baking:** When melted chocolate is needed in a recipe or for decoration work, simply place the chocolate in a heatproof bowl near the hotplate. This method is easier than placing over a pan of hot water, which can often splash into the chocolate and spoil it.
- 6. Baking:** Syrup tins and jam jars with only a little left in them are easier to empty when they have warmed on the hob.
- 7. Cooking:** If a recipe requires a small amount of fried or softened onion, place the finely chopped onion and a little butter or oil in a heatproof bowl on or near the hotplate to soften. I use this method often, because it is so much easier than having to wash up a frying-pan! Many different types of vegetables can be prepared this way before adding to a recipe.
- 8. Cooking:** To make breadcrumbs, simply place the bread on a baking sheet in the lower oven and allow to dry out. Crush and store for future use.
- 9. Cooking:** To make croutons, cut the bread into small cubes, place in a shallow cast iron dish with a little oil and fry, using the base of the main oven. (If the oven is not in use, fry on the hotplate) Drain, spread out on a baking sheet and put to crisp in the lower oven. Croutons can be frozen for use when required.
- 10. Drying:** An abundance of fresh herbs need not be wasted. Place on a baking sheet, after washing and patting dry with kitchen paper, and leave to dry in the lower oven. Store for future use.
- 11. Drying:** Cooker rice can be spread out on a baking sheet and left to dry in the lower oven.
- 12. Baking:** When making fruit cakes, wash the dried fruit, place on a baking sheet and allow to dry off in the lower oven before use. Moist fruit will sink to the bottom of a cake and spoil it.
- 13. Preserving:** When you are bottling, the depth of the main oven makes it easy to sit a tray of bottled fruit all on the same shelf to cook in one session.
- 14. Preserving:** When you are making jam the graduated hotplate enables you to control the simmering of a large preserving pan much more easily than on a conventional cooker, where the pan is too large for the burner or ring. The warming of sugar, drying of the prepared fruit and the warming of jars and bottles can all be done with plenty of space using the lower oven and plate rack, if you have one.

FAULT FINDINGS

PROBLEM	CAUSE	REMEDY
1. Poor Flue Draught:	(a) Obstruction. (b) Chimney too low. (c) Chimney too wide. (d) Crack in wall. (e) No flue liner	(a) Clear and clean. (b) Raise height above ridge. (c) Fit flue liner 150mm (6") (d) Repair cracks. (e) Fit flue liner
2. Excessive Flue Draught	(a) High chimney.	(a) Fit draught stabiliser venting to the outside atmosphere.
3. Down Draught:	(a) High trees (b) High buildings (c) Low chimney. (d) Positive pressure zone.	(a) Raise chimney height. (b) Raise chimney height. (c) Raise chimney height. (d) Check flue termination
4. Cooker Smoking:	(a) Insufficient primary air. (b) Chimney choked. (c) Downdraught. (d) Poor combustion.	(a) Provide additional room air inlet or adjust burner air intake. (b) Clean chimney. (c) Raise chimney height. (d) Check air supply.
5. Hot Plate Not Heating:	(a) Burner cutting out. (b) Utensils not flat.	(a) Increase cooker thermostat setting. (b) Use machined based utensils.
6. Oven Not Heating:	(a) Flueways blocked with soot.	(a) Clean out.
7. Radiators Not Heating:	(a) Circulating pump not working. (b) Room thermostat set too low (c) Air in system. (d) Pipe system faulty. (e) Excessive number of radiators (f) Radiator valves not balanced. (g) By-pass incorrectly set.	(a) Check and replace if defective. (b) Increase setting (c) Bleed system. (d) Check pipe sizes and circuit. (e) Turn off un-needed radiators. (f) Adjust valves to give an even flow. (g) Adjust by-pass valve
8. Domestic Hot Water Cylinder not getting hot enough:	(a) Cylinder too large. (b) Flow pipe too large. (c) 'Balancing valve' is closed. (d) Cylinder thermostat set too low. (e) Circulating pump not working. (f) Motorised valve not opening	(a) Use 180 litre cylinder. (b) Use 28mm bore pipe. (c) Open 'balancing valve'. (d) Increase thermostat setting. (e) Check and replace if defective. (f) Check and replace if defective.
9. Intermittent Performance:	(a) Cooker starved of primary air. (b) Extraction fan in room. (c) Dirt in nozzle. (d) Dirty burner. (e) Faulty Thermistor/Thermocouple (f) Dirty flueways. (g) Dirty Oil Filter (h) Worn nozzle	(a) Provide air inlet in room. (b) Provide additional air inlet in room. (c) Clean or replace nozzle. (d) Service burner. (e) Replace if defective. (f) Clean flueways. (g) Clean or replace (h) Replace nozzle
10. Domestic Hot Water Rusty:	(a) Leak in indirect cylinder. (b) Incorrect cylinder fitted.	(a) Replace cylinder. (b) Check with installer.

It is of the utmost importance to keep the flue pipe and chimney clear of deposits. Blocked or partially obstructed flueways and chimneys will cause dangerous fumes to be emitted into the room, these may well be invisible.

**Manufactured by
Waterford Stanley Ltd.,**
Unit 401-403, IDA Industrial Estate, Cork Road,
Waterford, Ireland.
Tel: (051) 302300 Fax (051) 302315
www.waterfordstanley.com

